

MINSTER DISTRIBUTION

WIRE PRODUCTS, AGRICULTURAL AND BUILDING SUPPLIES

ALVELEY INDUSTRIAL ESTATE,
ALVELEY,
BRIDGNORTH,
UNITED KINGDOM
SALES@MINSTERDISTRIBUTION.CO.UK
01746 780330
MINSTERDISTRIBUTION.CO.UK

CONTENTS

1. GALVANISED HEXAGONAL NETTING
2. STOCK FENCE
3. PREMIUM STOCK FENCE
4. PLAIN & COATED WIRE
5. LIGHT WELDMESH PANELS
6. LIGHT WELDMESH ROLLS
7. SECURITY WIRE
8. SECURITY FENCE
9. CHAINLINK FENCE ROLLS
10. PALING FENCE
11. POTATO BAGS
12. TO 15. NAILS
16. SHEEP HURDLES
17. TO 18. WATER & FEED TROUGHS
19. HAY BASKETS
20. GATES
21. GALVANISED CORRUGATED/ONDULINE SHEETS
22. ROOFING ACCESSORIES
23. TIMBER
24. TIMBER ACCESSORIES
25. FENCING PANELS & ACCESSORIES
26. WOODEN GATES
27. BRIDLE GATES
28. GATE FURNITURE
29. TOOLS

WHO WE ARE

MINSTER HAS BEEN ESTABLISHED FOR OVER 25 YEARS SUPPLYING WIRE PRODUCTS TO THE UK MARKET, WITH EXPERIENCE IN A WIDE NUMBER OF INDUSTRIES RANGING FROM SECURITY FENCE & AGRICULTURAL PRODUCTS TO BUILDING SUPPLIES. MINSTER HAS A WIDE RANGE OF SOLUTIONS FOR ALL APPLICATIONS.

OUR VISION

MINSTER DELIVERS HIGH QUALITY PRODUCTS THROUGH OUR DEDICATED TEAM OUT OF OUR DISTRIBUTION HUB IN ALVELEY, SHROPSHIRE. OUR MANAGEMENT AND STAFF WORK HARD TO ACHIEVE LONG-LASTING RELATIONSHIPS WITH ALL OUR CUSTOMERS AND SUPPLIERS.

OUR MISSION

CONSTANTLY WORKING ON SERVICE AND PRODUCT OFFERING, WE ARE ENTIRELY FOCUSED ON THE CUSTOMERS SATISFACTION THROUGH BOTH OUR PRODUCTS AND SERVICES PROVIDED.

OUR STRATEGY

- TO MAINTAIN AND IMPROVE ON CUSTOMER RELATIONSHIP THROUGH OUR SERVICE AND PRODUCT OFFERING.
- TO INCREASE AND INTRODUCE NEW PRODUCTS IN OUR WIRE, AGRICULTURE AND BUILDING PRODUCTS BASED ON THE CLOSE RELATIONSHIPS WITH OUR MANUFACTURERS AND SUPPLIERS.

A VAST RANGE OF OUR PRODUCTS ARE AVAILABLE FOR NEXT DAY DELIVERY. SEND YOUR ENQUIRIES TO SALES@MINSTERDISTRIBUTION.CO.UK OR CALL THE OFFICE ON **01746 780330**.

GALVANISED HEXAGONAL NETTING

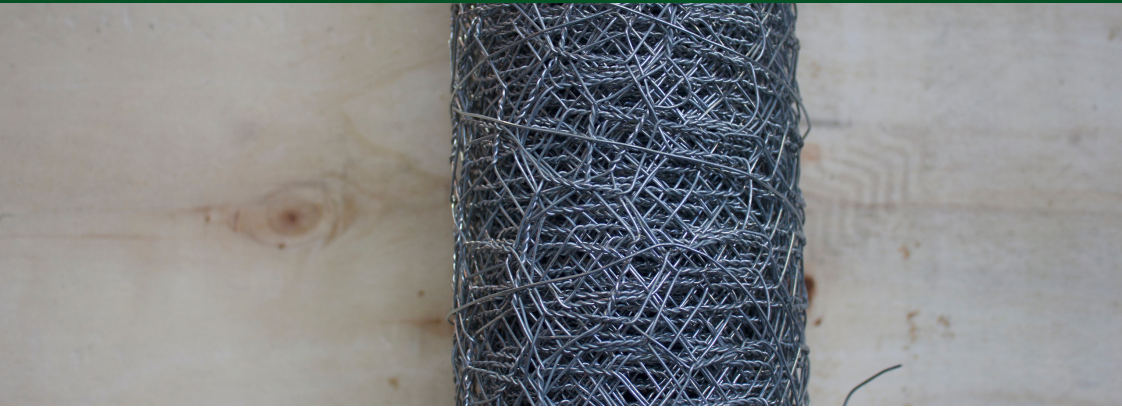

- MADE FROM PRE-GALVANISED WIRE
- JOINTS ARE SPOT WELDED TO FORM THE SQUARE MESH APERTURE.
- SUPPLIED AS AS A ROLL

AVAILABLE IN 0.6MM 1.0MM 1.6MM IN GALVANISED
SOME SIZES AVAILABLE IN PVC COATED

- PET CAGES / KENNELS
- SECURITY CAGES
- FRUIT CAGES AND FRAMES
- CLIMBING PLANT SUPPORT
- DOG FENCING
- LEAF PROTECTION FOR PONDS
- CONSTRUCTION USES

Hole Size MM		13				19				25				31				38				50			
Roll Length Meters		5	10	25	50	5	10	25	50	5	10	25	50	5	10	25	50	5	10	25	50	5	10	25	50
Height in MM	600	✓	✓	✓	✓		✓			✓	✓	✓	✓			✓	✓								
	900	✓	✓	✓	✓		✓			✓	✓	✓	✓	✓	✓	✓	✓								
	1050																✓								
	1200	✓	✓	✓	✓				✓	✓	✓	✓	✓				✓								
	1500											✓	✓											✓	✓
	1800			✓								✓	✓				✓				✓			✓	✓



STOCK FENCE



- SUPPLIED IN 25, 50, 100, 300 & 500M LENGTHS
- IDEAL FOR CREATING POST AND WIRE FENCING
- GALVANISED WIRE

Roll Length Meters		25	50	100	300	500
SPEC	L5-60-15			✓		
	C8-80-15	✓	✓	✓		
	C8-80-22		✓	✓		
	HT8-80-15	✓	✓	✓	✓	✓
	HT8-80-22	✓	✓	✓	✓	✓
	HT8-80-30	✓	✓	✓	✓	✓
	L10-120-15		✓			
HT13-190-15		✓	✓			

- CATTLE FENCING
- PIGS
- SHEEP
- FOREST BOUNDARIES
- DOG
- DEER
- BADGER
- SECURITY

VICEBITE FENCE STAY BRACKET



HT8 / 80 / 15

WIRE SPECIFICATION:

HT = HIGH TENSILE
C = MEDIUM
L = LIGHT

TOTAL NUMBER OF HORIZONTAL WIRES

NOTE THAT SPACING VARIES WITH WIRES USUALLY CLOSER TOGETHER AT THE BOTTOM

SPACING BETWEEN VERTICAL WIRES (CM)

AFFECTS THE OVERALL STRENGTH OF THE FENCE (THE CLOSER TOGETHER THE STRONGER THE FENCE)

FENCE HEIGHT (CM)

CHOSEN BASED ON THE PARTICULAR ANIMAL BEING ENCLOSED/KEPT OUT

PREMIUM STOCK FENCE



TORNADO®

WE ALSO STOCK A WIDE SELECTION OF FENCING FROM THE TORNADO RANGE.
THE RANGE OF WIRE FENCING FROM TORNADO IS SUITABLE FOR:

- BADGER
- DEER
- HORSE
- OTTER
- DOG
- RABBIT
- GAME/BOAR

HT8-80- RANGE



PLAIN & COATED WIRE



PLAIN WIRE

- GALVANISED STEEL
- IPROVIDED AS A COIL
- RESISTANT TO CORROSION AND RUST

Wire Diamater MM		High Tensile			Mild Steel								
		2.5	3.15	4.0	1	1.25	1.6	2.0	2.5	3.15	4.0	5.0	
Weight in KG	0.5				✓	✓	✓	✓	✓				
	1						✓						
	5	✓	✓				✓	✓	✓	✓	✓		
	10	✓	✓				✓	✓	✓	✓	✓		

AVAILABLE IN 2.0MM, 2.5MM, 3.0MM, 4.0MM, 5.0MM IN GALVANISED

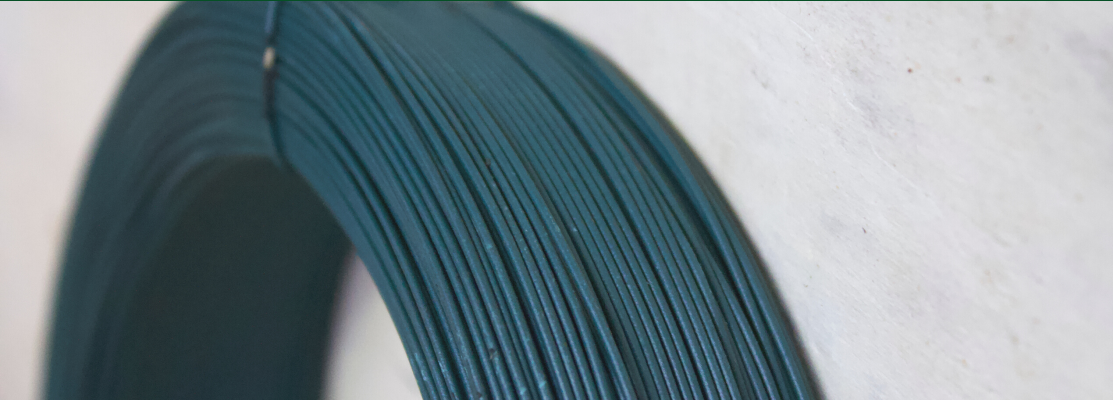

COATED WIRE

- GALVANISED STEEL
- IPROVIDED AS A COIL
- RESISTANT TO CORROSION AND RUST

Wire Diamater MM		PVC Coated					
		1	1.3	1.4/2	1.7/2.5	2.24/3.15	3.5
Roll Length M	25					✓	
	30	✓					
	50		✓				
	52				✓	✓	
	76				✓	✓	
Weight in KG	0.5			✓			
	5					✓	
	25						✓

AVAILABLE IN 2.0MM, 2.5MM, 3.0MM, 4.0MM, 5.0MM IN GALVANISED



LIGHT WELDMESH PANELS



- MADE FROM PRE-GALVANISED WIRE
- JOINTS ARE SPOT WELDED TO FORM THE SQUARE MESH APERTURE.
- SUPPLIED AS FLAT MESH SHEETS ARE CAN BE USED FOR ENDLESS APPLICATIONS

- PET CAGES / KENNELS
- SECURITY CAGES
- FRUIT CAGES AND FRAMES
- CLIMBING PLANT SUPPORT
- DOG FENCING
- LEAF PROTECTION FOR PONDS
- CONSTRUCTION USES

AVAILABLE IN 2.0MM, 2.5MM, 3.0MM, 4.0MM, 5.0MM IN GALVANISED

Hole Size MM		25 x 25			38 x 38			50 x 25			50 x 50			75 x 13			75 x 25			75 x 75			100 x 100			150 x 75			
Sheet length MM		1800	2440	3600	1800	2440	3600	1800	2440	3600	1800	2440	3600	1800	2440	3600	1800	2440	3600	1800	2440	3600	1800	2440	3600	1800	2440	3600	
Sheet Width MM	600																			✓									
	900							✓				✓					✓			✓							✓		
	1220	✓	✓			✓			✓		✓	✓					✓				✓				✓			✓	
	1800			✓									✓				✓						✓						

AVAILABLE IN 2.0MM, 2.5MM, 3.0MM, 4.0MM, 5.0MM IN GALVANISED



LIGHT WELDMESH ROLLS

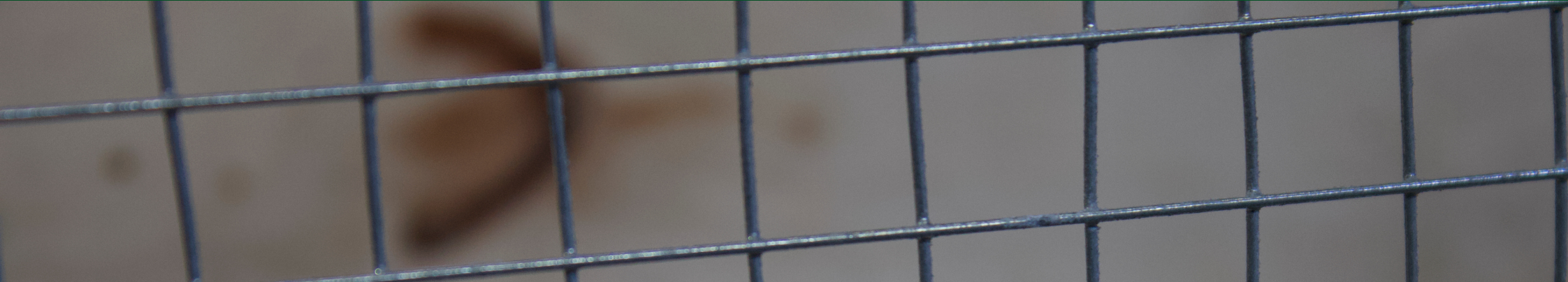

- MADE FROM PRE-GALVANISED WIRE
- JOINTS ARE SPOT WELDED TO FORM THE SQUARE MESH APERTURE.
- SUPPLIED AS AS A ROLL

SOME SIZES AVAILABLE IN PVC COATED

- PET CAGES / KENNELS
- SECURITY CAGES
- FRUIT CAGES AND FRAMES
- CLIMBING PLANT SUPPORT
- DOG FENCING
- LEAF PROTECTION FOR PONDS
- CONSTRUCTION USES
- POULTRY

Hole Size MM		6 x 6				13 x 13				1/2 x 25				25 x 25				50 x 50			
Roll Length Meters		6	10	15	30	6	10	15	30	6	10	15	30	6	10	15	30	6	10	15	30
Height in MM	600					✓			✓					✓			✓				✓
	900	✓			✓	✓	✓	✓	✓	✓	✓		✓	✓		✓	✓	✓			✓
	1200	✓			✓	✓			✓	✓			✓	✓			✓	✓			✓

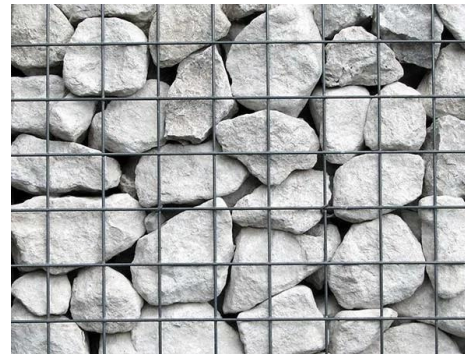

SECURITY WIRE



BARBED WIRE

- TWIN STRAND BARBED WIRE
- WITH INTERLOCKING 4 POINT BARBS
- GALVANISED

Wire Diameter MM		2.5 MS	1.6 HT	2.0 HT
Roll Length Meters	15	✓		
	200	✓	✓	✓

AVAILABLE IN 15M AND 200M LENGTHS



RAZOR WIRE

- GALVANISED STEEL
- STAINLESS STEEL BLADE
- SUITABLE FOR ALL TYPES OF SECURITY FENCING
- WRAPPED IN CARDBOARD FOR SAFE TRANSPORTATION

Wire Diameter MM		450	710	955	Flat Razor
Roll Length Meters	10	✓	✓	✓	
	50				✓

AVAILABLE IN 10M AND 50M LENGTHS



BARBED WIRE ANGLE BRACKETS 400MM

- HEAVY DUTY GALVANISED STEEL
- DESIGNED TO FIT RAZOR/BARBED WIRE TO A FENCE OR WALL
- HOLES ARE DESIGNED TO BE USED WITH ANCHOR BOLTS AND COACH SCREWS

AVAILABLE IN 2.0MM, 2.5MM, 3.0MM, 4.0MM, 5.0MM IN GALVANISED

SECURITY FENCE

GALVANISED AND PVC COATED AVAILABLE



GALVANISED PALING SECURITY FENCE

METAL PALING FENCING IS ONE OF THE MOST SECURE FENCES THAT YOU CAN HAVE. IT IS CONSTRUCTED OF PRESSED STEEL PALINGS WHICH ARE FIXED TO CROSS-RAILS WITH SECURITY BOLTS (DESIGNED TO PREVENT REMOVAL). IT CAN HAVE MATCHING GATES AND IS AVAILABLE IN MANY HEIGHTS. THE FENCE CAN BE COLOUR COATED PRIOR TO ERECTION TO GIVE IT A VERY ATTRACTIVE APPEARANCE.

V-MESH SECURITY FENCE

WHEN IT COMES TO SECURITY FENCING 'V' MESH IS ONE OF THE MOST COMPREHENSIVE, COST EFFECTIVE SOLUTIONS. PROVIDES EXCELLENT SECURITY, LOOKS AND VALUE FOR MONEY WITHOUT COMPROMISING ON ANY OF THE FEATURES YOU WOULD NEED FROM A TOP OF THE LINE SECURITY FENCE. AVAILABLE IN VARIOUS STANDARD RAL COLOURS TO ENHANCE THE OVERALL APPEARANCE OF YOUR SECURITY FENCING SYSTEM. A POWDER COATED FINISH INCREASES RESILIENCE AGAINST WEATHERING AND VANDALISM.

Hole Size Inches		2 x 2		3 x 1		3 x 3		4 x 4	
Roll Length Meters		12.5	25	12.5	25	12.5	25	12.5	25
Height in MM	900	✓	✓			✓	✓	✓	✓
	1200	✓	✓		✓	✓	✓	✓	✓
	1500	✓	✓						
	1800	✓	✓		✓				
	2100		✓						
	2400		✓	✓					

Galvanised or Painted Angle Iron Chainlink Post

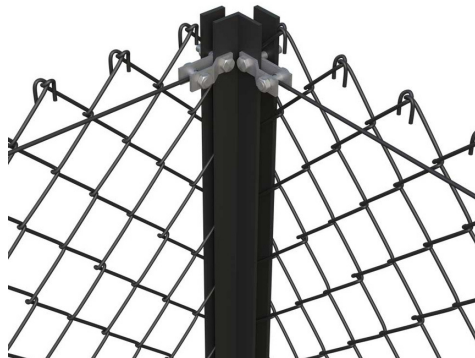

Galvanised Angle Cleats
50 x 50 x 6MM
38 x 38 x 6MM

Galvanised Water Bar
25MM, 30MM, 40MM, 50MM
6MM Thick & 3.66M Lengths

Galvanised Eye Bolts
200 x 10MM
240 x 10MM
260 x 10MM
300 x 10MM
Other Sizes Available

Galvanised Stretcher Bar
900MM
1250MM
1410MM
1850MM

CHAINLINK FENCE ROLLS

GALVANISED AND PVC COATED AVAILABLE



- MADE TO A VERY HIGH STANDARD.
- THE CHAIN-LINK IS GREEN PVC COATED
- FULLY GALVANIZED CORE WIRE UNDERNEATH THE PLASTIC COATING
- LONG-LASTING
- AN ATTRACTIVE, INCONSPICUOUS FENCE.

Hole Size MM		50mm		
Roll Length Meters		10	12.5	25
Height in MM	900	✓		✓
	1200	✓		✓
	1500			✓
	1800	✓	✓	✓
	2400		✓	✓
	2700		✓	
	3000		✓	

AVAILABLE IN 2.0MM 2.5MM 3.0MM IN GALVANISED
 AVAILABLE IN 1.7/2.5MM 1.9/3.0MM 2.24/3.15MM PVC COATED
 HEAVIER GAUGE AVAILABLE

- GARDEN FENCING
- AMENITY FENCING
- SPORTS AREA FENCING
- PERIMETER FENCING

Galvanised or Painted Angle Iron Chainlink Post

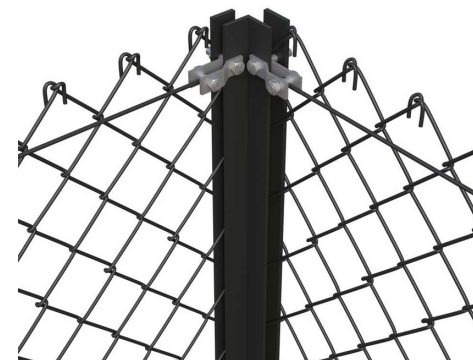

Galvanised Angle Cleats

50 x 50 x 6MM
38 x 38 x 6MM

Galvanised Water Bar

25MM, 30MM, 40MM, 50MM
6MM Thick & 3.66M Lengths

Galvanised Eye Bolts

200 x 10MM
240 x 10MM
260 x 10MM
300 x 10MM
Other Sizes Available

Galvanised Stretcher Bar

900MM
1250MM
1410MM
1850MM

PALING FENCE



PINE

- 1.1M HIGH CLEFT CHESTNUT FENCING
- 2 OR 3 ROWS OF BEST GALVANISED 2MM WIRE,
- 4 STRANDS PER ROW FOR EXTRA STRENGTH.
- ROLL IS 9.1M LONG



CHESTNUT



OAK

- THE DEMARCATION OF A BOUNDARY.
- HIGHWAY FENCING.
- FENCING FOR LIVESTOCK.
- PERMANENT OR TEMPORARY FENCING ON A SITE.
- AN EMERGENCY CORDON.
- RETAINER FOR EROSION PREVENTION (SOIL AND BEACHES)
- FENCING FOR EVENTS - CROWD CONTROL.

**AVAILABLE IN 2.0MM, 2.5MM, 3.0MM, 4.0MM, 5.0MM
IN GALVANISED**

Material		Oak		Pine		Cleft	
Line Wires		2	3	2	3	2	3
Height MM	900					✓	✓
	1050		✓		✓	✓	✓
	1200					✓	✓
	1800		✓		✓	✓	✓



POTATO BAG TIES

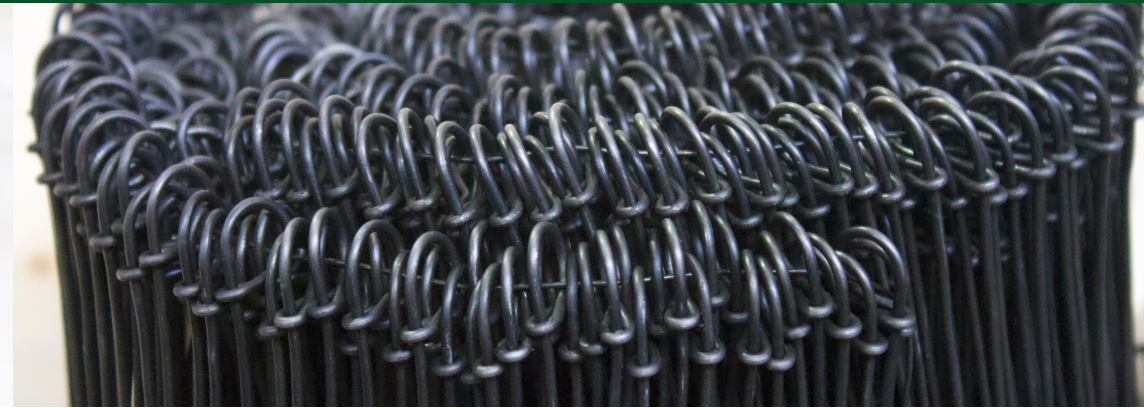

Potato Bag Ties	
Size	QTY
150mm	1000
225mm	1000
250mm	1000
300mm	1000
600mm	1000
700mm	1000
800mm	1000
900mm	1000
1000mm	1000

WIRE TIES ARE IDEAL FOR SEALING HESSIAN SACKS AND HEAVY DUTY POLYTHENE BAGS OR TUBING. MANUFACTURED FROM PVC COATED 17 GAUGE THICKNESS GALVANISED STEEL TO ENSURE A RUST FREE CLOSURE. THE SMOOTH GREEN PLASTIC FINISH ENSURES THE MATERIAL BEING TIED IS NOT SCRATCHED OR DAMAGED.

**A PACK OF 1000 METAL WIRE BAG TIES.
LENGTH: 9 INCHES.**

TWISTING TOOL FOR WIRE TIES



THIS TOOL IS AN ESSENTIAL FOR TIGHTENING WIRE TIES. THE SIMPLE MECHANISM TWISTS AND TIGHTENS PRE-FORMED LOOPED WIRE TIES AND THE RUBBER HAND GRIP HAS ERGONOMIC GROOVES FOR A FIRM HOLD.

DESIGNED TO QUICKLY SECURE LOOPED WIRE TIES JUST FEED THE TWO LOOPS OVER THE HOOK ON THE TOOL THEN PULL AND TWIST THE HANDLE TO SECURE THE WIRE. LENGTH OF TWISTING TOOL FOR WIRE TIES IS 300 MM WHEN CLOSED, 430 MM WHEN EXTENDED.

NAILS



ROUNDWIRE

Finish		Bright																Galvanised															
Dia MM		1.8	2	2.36	2.65	3.35	3.75	4	4.5	5	5.6	6	6.7	8	1.8	2	2.36	2.65	3.35	3.75	4	4.5	5	5.6	6	6.7	8						
Length MM	25		✓												✓																		
	30			✓												✓		✓															
	40				✓												✓	✓															
	50					✓											✓	✓	✓														
	65						✓											✓	✓														
	75							✓											✓														
	90									✓										✓													
	100										✓										✓												
	120																																
	125																																
	150																																
	180																																
	200																												✓				

OVAL

Finish		Bright	Galvanised
Dia MM		1.80	1.8
Length MM	25	✓	
	30	✓	✓
	40	✓	✓
	50	✓	✓
	65	✓	
	75	✓	
	90		
	100	✓	✓
	120		
	125	✓	
	150	✓	
	200		

OUR RANGE OF NAILS CAN BE SUPPLIED PREPACKED IN SIZES FROM 250G POLY BAGS TO 20KG PLASTIC TUBS. ALL PREPACKED NAILS COME WITH STANDARD LABEL SHOWING SIZE AND WEIGHT.

PERSONALISED LABELS TO CUSTOMERS OWN DESIGN CAN BE SUPPLIED

NAILS



PANEL PINS

Finish		Bright			
Dia MM		1.40	1.60	2.00	2.65
Length MM	15	✓			
	20		✓		
	25		✓		
	30		✓		
	40		✓		
	50			✓	
	75				✓

STAPLES

Finish		Galvanised					
Dia MM		1.6	2.0	2.65	3.55	4.00	5.00
Length MM	15	✓					
	20		✓				
	25			✓			
	30				✓		
	40					✓	
	50						✓

LOST HEAD

Finish		Bright				Galvanised			
Dia MM		2.36	2.65	3.35	3.75	4.50	2.36	2.65	3.35
Length MM	40	✓					✓		
	50		✓					✓	
	60			✓					
	65			✓					✓
	75				✓				
	100					✓			

SQUARE TWIST

Finish		Galvanised	Stainless
Dia MM		3.75	3.75
Length MM	30	✓	✓
	40	✓	✓

OUR RANGE OF NAILS CAN BE SUPPLIED PREPACKED IN SIZES FROM 250G POLY BAGS TO 20KG PLASTIC TUBS. ALL PREPACKED NAILS COME WITH STANDARD LABEL SHOWING SIZE AND WEIGHT.

PERSONALISED LABELS TO CUSTOMERS OWN DESIGN CAN BE SUPPLIED

NAILS



ANNULAR RING

Finish		Bright						Galvanised		Sheradised						
Dia MM		2.00	2.36	2.65	3.35	3.75	5.00	5.60	3.35	3.75	2.0	2.36	2.65	3.35	3.75	5.0
Length MM	20	✓									✓					
	25	✓									✓					
	30		✓									✓				
	40		✓	✓									✓			
	50			✓	✓				✓				✓	✓		
	65				✓				✓					✓		
	75					✓				✓				✓		
	90					✓									✓	
	100						✓									✓
125							✓									

VENEER PINS

Finish		Bright
Dia MM		1.00
Length MM	13	✓
	15	✓
	20	✓
	25	✓
	30	✓

NAIL GUN

Finish		Galvanised Gun Nails		Galvanised Paslode Nails	
Dia MM		2.80	3.10	2.80	3.10
Length MM	51	✓		✓	
	63	✓	✓	✓	✓
	76		✓		✓
	90		✓		✓

STAINLESS ARS

Dia MM		1.8	2.65	3.35	3.75	4.50	5.60	6.00
Length MM	20			✓				
	25			✓				
	30		✓		✓			
	31	✓						
	32		✓					
	35			✓				
	38		✓	✓				
	40		✓	✓				
	50		✓	✓				
	60			✓				
	65		✓	✓				
	75			✓	✓			
	90				✓			
	100				✓	✓		
	125						✓	
150							✓	

OUR RANGE OF NAILS CAN BE SUPPLIED PREPACKED IN SIZES FROM 250G POLY BAGS TO 20KG PLASTIC TUBS. ALL PREPACKED NAILS COME WITH STANDARD LABEL SHOWING SIZE AND WEIGHT.

PERSONALISED LABELS TO CUSTOMERS OWN DESIGN CAN BE SUPPLIED

NAILS



CLOUT

Finish		Galvanised			
Dia MM		2.65	3.35	3.75	4.50
Length MM	20	✓			
	25	✓			
	30	✓	✓		
	40	✓	✓		
	50	✓	✓		
	65	✓	✓		
	75			✓	
	100				✓

ELH CLOUT

Finish		Galvanised
Dia MM		3.00
Length MM	8	✓
	10	✓
	13	✓
	15	✓
	20	✓
	25	✓
	30	✓
	40	✓
	50	✓

OUR RANGE OF NAILS CAN BE SUPPLIED PREPACKED IN SIZES FROM 250G POLY BAGS TO 20KG PLASTIC TUBS. ALL PREPACKED NAILS COME WITH STANDARD LABEL SHOWING SIZE AND WEIGHT.

PERSONALISED LABELS TO CUSTOMERS OWN DESIGN CAN BE SUPPLIED

WE OFFER TIMBER STRUCTURAL SCREWS ON REQUEST

SHEEP HURDLES



OUR HURDLES ARE AVAILABLE IN 1220MM, 1525MM & 1830MM LENGTHS.

THEY ARE ALL 7 BAR

DROP PIN



INTERLOCKING



WATER & FEED TROUGH



FEATURE A ROLLED TOP FOR ADDED STRENGTH AND STABILITY. THE DRAIN HAS BEEN PRE-DRILLED AND A RUBBER BUNG IS PROVIDED AS STANDARD. AN IDEAL SOLUTION TO HELP MAINTAIN A FRESH SUPPLY OF WATER TO YOUR LIVESTOCK IN THE FIELD AND DURING HOUSING. THESE METAL TROUGHS CAN BE USED DECOARTIVLEY TO PLANT FLOWERS IN YOUR GARDEN. ADDING A UNIQUE FEATURE TO YOUR GARDEN. PLUS, VERY EASY TO MAINTAIN!

CATTLE WATER TROUGH
FROM 900MM (L) X 457MM (D)
TO 2400MM X 457MM

LARGE CAPACITY WATER TROUGH
3048MM (L) X 1220MM (W) X
610MM(D)

SHEEP WATER TROUGH
1200MM (L) X 457 (W) X 267 (D)
TO
1800MM X 457MM X 267MM



WATER & FEED TROUGHS



FEATURE A ROLLED TOP FOR ADDED STRENGTH AND STABILITY. THE DRAIN HAS BEEN PRE-DRILLED AND A RUBBER BUNG IS PROVIDED AS STANDARD. AN IDEAL SOLUTION TO HELP MAINTAIN A FRESH SUPPLY OF WATER TO YOUR LIVESTOCK IN THE FIELD AND DURING HOUSING. THESE METAL TROUGHS CAN BE USED DECOARTIVLEY TO PLANT FLOWERS IN YOUR GARDEN. ADDING A UNIQUE FEATURE TO YOUR GARDEN. PLUS, VERY EASY TO MAINTAIN!

A105

DRINKER SUITABLE FOR ALL LIVESTOCK. OUR BEST SELLING MAINS PRESSURE TROUGH. HEAVY GAUGE STEEL, GALVANISED AFTER MANUFACTURE. FINISHED WITH NO SHARP EDGES OR CORNERS TO PROTECT YOUR ANIMALS. FITTED WITH BS1212/PT2 MAINS PRESSURE BALL VALVE AS STANDARD.



A108

DRINKER SUITABLE FOR ALL ANIMALS. CAN BE USED IN TWO PENS USING ONE WATER SUPPLY. HEAVY GAUGE STEEL, GALVANISED AFTER MANUFACTURE. FINISHED WITH NO SHARP EDGES OR CORNERS TO PROTECT YOUR ANIMALS. FITTED WITH BS1212/PT2 MAINS PRESSURE BALL VALVE AS STANDARD.



JFC MICRO DRINKER

THE MICRO DRINKER FROM JFC IS DESIGNED WITH A DOUBLE WALL FOR EXTRA DURABILITY AND STRENGTH, AND ROUND EDGES FOR ULTIMATE ANIMAL SAFETY. A FANTASTIC WAY TO ENSURE YOUR ANIMAL HAS FRESH CLEAN WATER EVERY TIME AND IS ALWAYS PROVIDED.



HAY BASKETS



QUALITY HAY BASKET FEEDERS

AVAILABLE IN MANY STYLES, INCLUDING SINGLE AND DOUBLE SIDED OPTIONS

IT IS LIGHTWEIGHT AND EASILY MOVED. CAN BE USED FOR BOTH FEEDING INDOORS AND OUT AND SUITABLE FOR USE WITH SHEEP OR CALVES. THE HAY BASKET FEEDERS ARE CONSTRUCTED FROM MESH AND GALVANISED FOR ANTI CORROSION PROTECTION.



DESIGNS MAY VARY



GATES



THE 7 BAR FIELD GATE IS QUICKLY BECOMING THE BEST SELLING FIELD GATE WITHIN THE RANGE AND IS NOW AVAILABLE FROM 610MM LONG TO 4880MM LONG.

THE 5 BAR CATTLE YARD GATE
7 BAR STANDARD FIELD GATE
HALF MESH FIELD GATE
FULLY MESH DEER GATE

Length M		0.9	1.2	1.5	1.8	2.1	2.4	2.7	3	3.1	3.3	3.6	3.9	4.2	4.5
Bar	5	✓	✓	✓	✓	✓	✓	✓	✓	✓	✓	✓	✓	✓	✓
	7	✓	✓	✓	✓	✓	✓	✓	✓	✓	✓	✓	✓	✓	✓

- 1143MM HIGH
- BOX SECTION RHS BRACING FOR IMPROVED STRENGTH
- TOP AND BOTTOM RAILS
- INTERMEDIATE RAILS
- SPRING LOADED SLIDING BOLT FASTENING
- 50MM X 50MM SHS SLEEVED HANGING STILE

AVAILABLE FROM STOCK IN A FULL RANGE OF SIZES
BETWEEN 610MM AND 4880MM
BESPOKE SIZES AVAILABLE AT EXTRA COST



GALVANISED CORRUGATED/ONDULINE ROOFING SHEETS



**GCORRUGATED ONDULINE ROOFING SHEET
BLACK**

2000MM X 950MM



**GCORRUGATED ONDULINE ROOFING SHEET
GREEN**

2000MM X 950MM



AVAILABLE IN FLAT AND CLEAR SHEETS

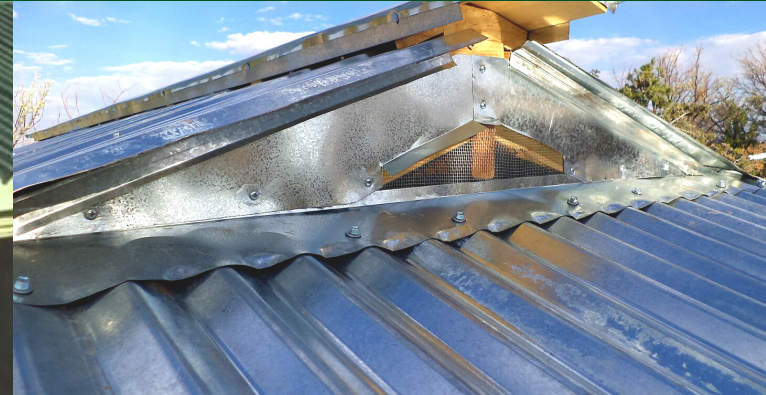

**CORRUGATED GALVANISED ROOFING SHEET
AVAILABLE IN FLAT AND CLEAR SHEETS**

5FT X 1M UP TO 12FT X 1M



**ONDULINE ROOFING NAILS
AVAILABLE IN BLACK AND GREEN**

ROOFING ACCESSORIES

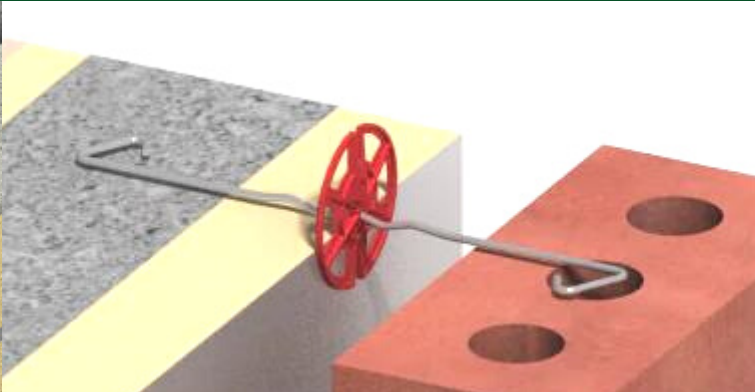
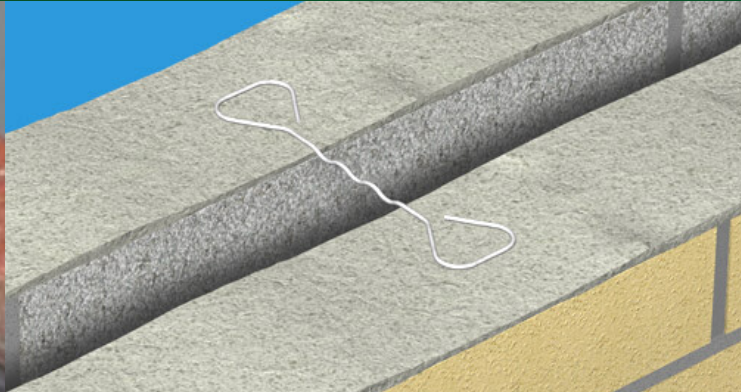

BOXED CAVITY WALL TIES

STAINLESS STEEL WALL TIES

PLASTIC INSULATION DISCS

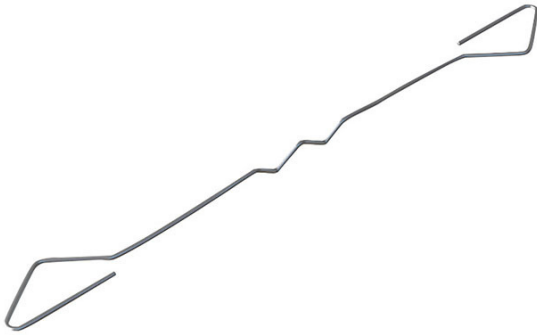

AVAILABLE IN 2 STYLES - EN2 & EN4
SIZES - 200MM TO 250MM
PACKS OF 50 TO 250

AVAILABLE IN BUTTERFLY & DOUBLE TRIANGLE
BUTTERFLY STOCKED IN 225MM & 200MM
DOUBLE TRIANGLE IN 225MM

AVAILABLE IN TUBES OF 50 & BAGS OF 250
75MM (3")

TIMBER



AVAILABLE IN THE FOLLOWING OPTIONS

GATE POSTS

2.1M X 125MM X 125MM 4WW
2.1M X 150MM X 150MM 4WW
2.1M X 175MM X 175MM 4WW
2.4M X 125MM X 125MM 4WW
2.4M X 150MM X 150MM 4WW
2.4M X 175MM X 175MM 4WW
2.4M X 200MM X 200MM 4WW

SAWN POSTS

1.8M/2.4M X 75MM X 75MM
1.8M/2.4M X 100MM 100MM
1.8M X 125MM X 75MM
1.8M X 150MM X 75MM
2.1M X 125MM X 75MM
2.1M X 150MM X 75MM
2.4M X 150MM X 75MM

POINTED POSTS

1.65M X 75/100MM
1.8M X 75/100MM
2.1M X 75/100MM
2.4M X 75/100MM
2.7M X 75/100MM
3.0M X 75/100MM

POINTED STRAINERS

2.1M X 100/125MM
2.1M X 125/150MM
2.1M X 150/175MM
2.4M X 100/125MM
2.4M X 125/150MM
2.4M X 150/175MM
2.4M X 175/200MM
3.0M X 100/125MM
3.0M X 125/150MM
3.0M X 150/175MM

TREATED SLEEPERS

2.4M X 200MM X 100MM SOFTWOOD SLEEPER

SAWN RAILS

3.6M X 87MM X 38MM
3.6M X 87MM X 38MM

3.6M X 100MM MACHINED ½ RD RAIL

GRAVEL BOARDS

3.6M X 150MM X 22MM
3.6M X 150MM X 47MM
1.8M / 2.4M/ 3.0M/ 4.5M X 150MM X 22MM

TIMBER ACCESSORIES

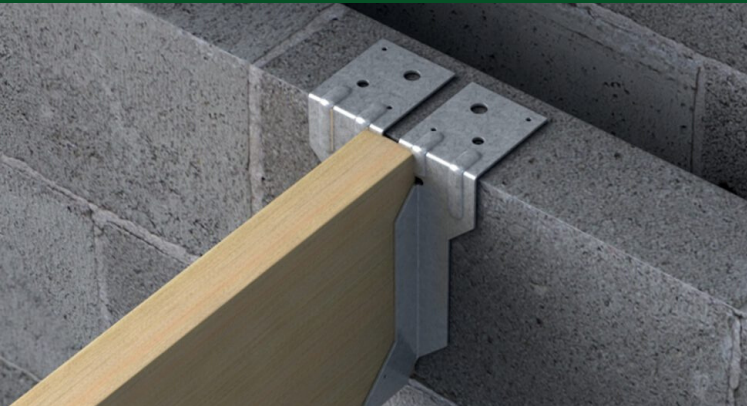

**GALVANISED TIMBER TO BRICK
JOIST HANGERS**

AVAILABLE IN MANY SIZES:
100MM (L) X 38MM (W) TO 250MM X 150MM

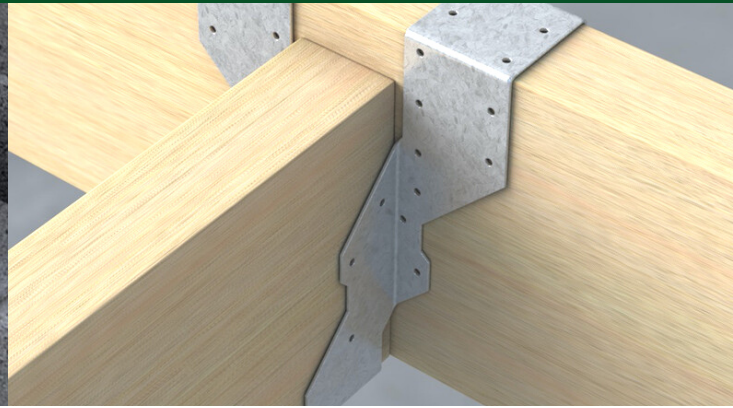

**GALVANISED TIMBER TO TIMBER
JOIST HANGERS**

AVAILABLE IN MANY SIZES AND STYLES:
38MM (W) TO 150MM (W)

A270, V81/450

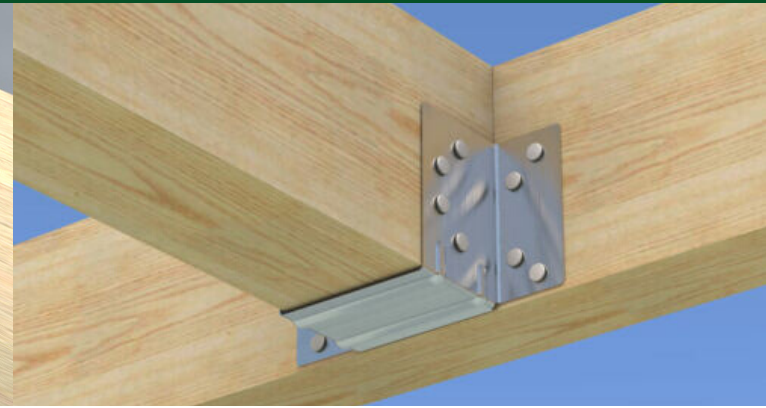

GALVANISED MINI HANGERS

AVAILABLE IN 2 SIZES:
38MM (W) TO 50MM



FENCING PANELS & ACCESSORIES



FENCE PANELS MADE BY HAND FROM SUSTAINABLY SOURCED TIMBER
ALL COMPONENTS HAVE BEEN GREEN PRESSURE TREATED BEFORE
ASSEMBLY TO IMPROVE LONGEVITY OF THE TIMBER
STRONG AND STURDY WITH SUPPORTING BACKING RAILS MEASURING
75X32MM EACH,
YET LIGHTWEIGHT ENOUGH FOR EASY INSTALLATION TO PRODUCE AN
ATTRACTIVE, LONG-LASTING GARDEN FENCE

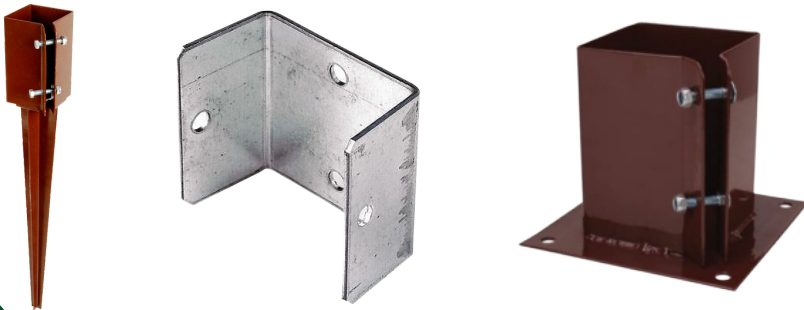

MANY ACCESSORIES AVAILABLE INCLUDING:

- POST SPIKES
- BOLT DOWN SUPPORTS
- FENCE PANEL CLIPS
- SECURITY PANEL CLIPS
- GRAVEL BOARDS
- CONCRETE POSTS

WOODEN GATES



WE HAVE 5, 6 & 7 BAR OPTIONS AVAILABLE FOR ORDER INCLUDING ALL FIXTURES AND FITTINGS

SOFT WOOD AND HARD WOOD OPTIONS ALSO AVAILABLE



BRIDLE & KISSING GATES



BRIDLE

AVAILABLE IN TIMBER OR GALVANISED STEEL, ALL OUR BRIDLE GATES ARE SELF-CLOSING BY MEANS OF AN OFFSET HINGER ARRANGEMENT FOR GREATER RELIABILITY WITH THE ADDED BENEFIT OF BEING VIRTUALLY MAINTENANCE FREE.

SUPPLIED IN EITHER 1 WAY OR 2 WAY OPENING, A STOCKPROOF HANDLE CAN BE SUPPLIED FOR ADDITIONAL SECURITY ON THE 2 WAY CLOSING GATES WHERE STOCK IS SITUATED ON BOTH SIDES OF THE GATE.

KISSING GATE

THE KISSING GATE IS USED IN SITUATION WHERE A GATE IS NOT A SUITABLE SOLUTION. IF THERE ARE STOCK RELATED ISSUES THE KISSING GATE WOULD BE A GOOD ALTERNATIVE.

ALL OUR KISSING GATES CAN EITHER BE GALVANISED FINISHED OR GALVANISED THEN POWDER COATED GREEN.

VARIOUS OPTIONS AVAILABLE BY CONTACTING US



GATE FURNITURE



**STANDARD HANGING POST-BARRIER GATE-114.3MM X 2000MM
AUTO/SLOTTED SLAM POST**

WOODEN GATE HANGING ACCESSORIES

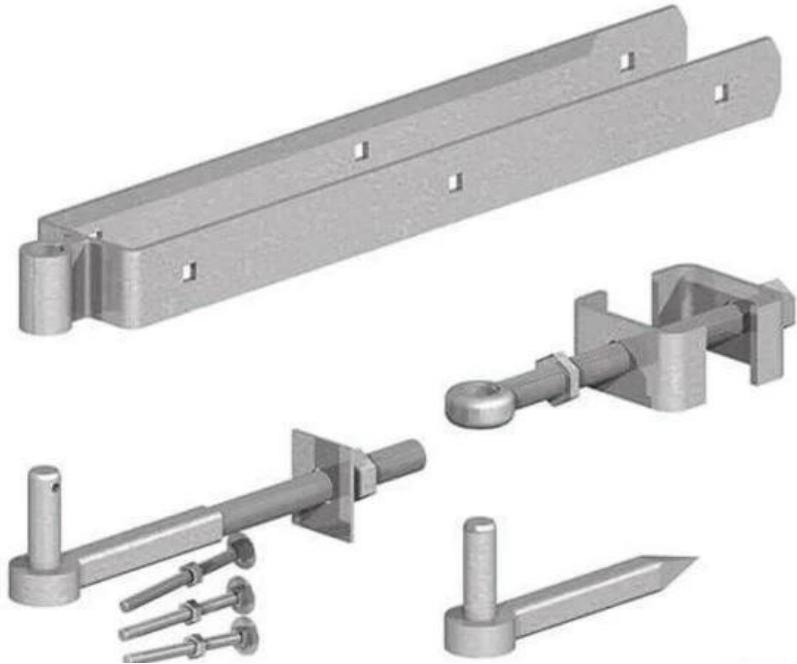

TOOLS



WE ALSO STOCK A WIDE SELECTION OF FENCING TOOLS. FROM CUTTING TOOLS AND TENSIONING TOOLS, TO STAPLE GUNS, WE HAVE YOU COVERED

STRAINING/TENSION TOOLS



STAPLE GUNS



WIRE JOINING TOOLS



WIRE CUTTING TOOLS



MINSTER DISTRIBUTION

**ALVELEY INDUSTRIAL ESTATE,
ALVELEY,
BRIDGNORTH,
UNITED KINGDOM**



SALES@MINSTERDISTRIBUTION.CO.UK



MINSTERDISTRIBUTION.CO.UK



01746 780330

MINSTER DISTRIBUTION RESERVE THE RIGHT TO CHANGE ANY SPECIFICATION AND ALTER DESIGN WITHOUT NOTICE. ALL SPECIFICATIONS ARE CORRECT TO THE BEST OF OUR KNOWLEDGE AT TIME OF GOING TO PRINT.